

## INSTRUCTIONS FOR INSTALLING YOUR WESLOCK PRODUCT

### Xanthis Active - Entry Handle



#### PARTS INCLUDED

Do not insert key, or unlock handle before installation. Doing so may result in removal of the cylinder assembly.

##### Exterior Grip Assembly

Exterior handle & thumb piece.

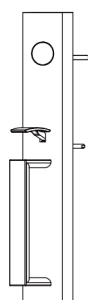

##### Exterior Deadbolt Assembly

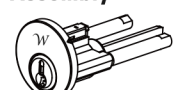

##### Deadbolt Latch

Engages strike with door closed.



##### Thumb Press Latch

Engages strike with door closed.



##### Foot Screw Cap Assembly



\* Only use one (1-2/5" OR 1-4/5") screw based on thickness of door.

##### Entry Keys (x2)

For unlocking the deadbolt.



##### Faceplates (x4)

For covering a mortise latch.

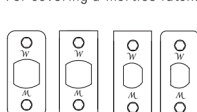

##### Wood Screws (x8)

For mounting strikes & faceplates.



##### Metal Screws (x8)

For mounting strikes & faceplates.



##### Interior Lever/Knob Assembly

##### Reversible

Interior knob / lever, rosette & spindle



##### Strikes (x 10 )

Install on door frame.

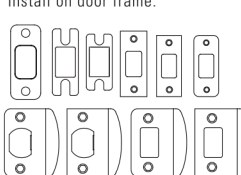

##### Assembly Screws (x8)

Pre-installed on Exterior Grip Assembly for mounting interior knob / lever assembly. (1-2/5" OR 2")



For mounting interior deadbolt assembly. (1-2/5" OR 2")

#### REQUIRED TOOLS

##### Measuring Tape

Or other measuring tool

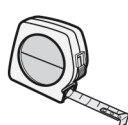

##### Screwdriver

Phillips and flat blade

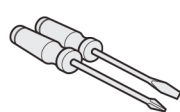

##### Wood Chisel

\*Only if prepping a new door

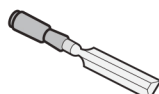

##### Allen Wrench

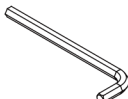

##### Writing Utensil

\*Only if prepping a new door

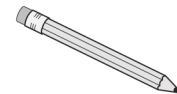

DOOR PREP INSTRUCTIONS 2 WESLOCK.COM

#### GLOSSARY OF TERMS

Technical language used in this document



**MORTISE**



**CROSS BORE**



**EDGE BORE**



**THUMB PRESS LATCH**



**DEADBOLT LATCH**

#### DETERMINE THE BACKSET OF YOUR DEADBOLT LATCH AND THUMBPRESS LATCH

The length of your latch assembly will be determined by your backset measurement.

##### MEASURE THE DOOR

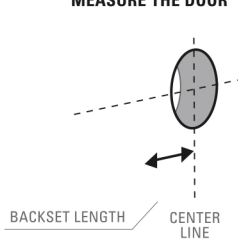

Measure distance between center of crossbore and edge of door.

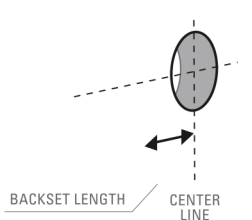

Measure distance between center of crossbore and edge of door.

##### IF MEASUREMENT = 2 3/8"

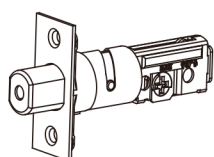

KEEP ADJUSTMENT PIN IN PLACE

Latch leaves the factory with this setting. No adjustment is necessary.

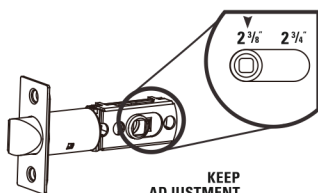

KEEP ADJUSTMENT PIN IN PLACE

##### IF MEASUREMENT = 2 3/4"

##### 1 GRASP ADJUSTMENT PIN ON BOTH SIDES

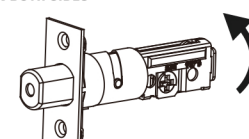

LIFT UP AND SLIDE BACK TO 2-3/4" SLOT

Slide adjustment pin back to 2 3/4" slot.

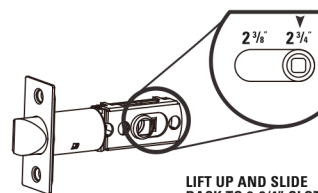

LIFT UP AND SLIDE BACK TO 2-3/4" SLOT

No adjustment is necessary. Leave extension attached to latch assembly.

#### INSTALLATION

Deadbolt latch must be extended prior to installation.

##### 7A. Insert Mortise Latches

##### MORTISE

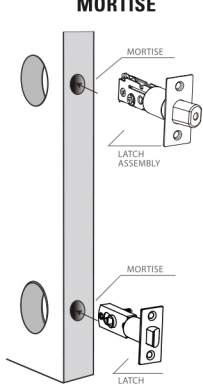

##### 7B. Install Exterior Deadbolt and Grip Assemblies

**A.** Insert deadbolt tailpiece into cam in deadbolt latch.

**B.** Align notches on grip housing with proper grooves (2-3/8" or 2-3/4") on latch. Slide on. At same time, align and insert foot screw through pre-drilled hole.

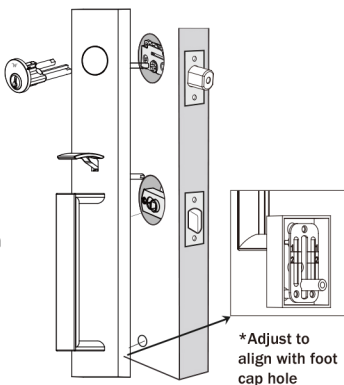

\*Adjust to align with foot cap hole

##### 7C. Install Interior Deadbolt and Knob/Lever Assemblies

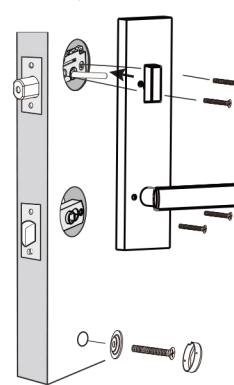

##### 7D. Install Strikes

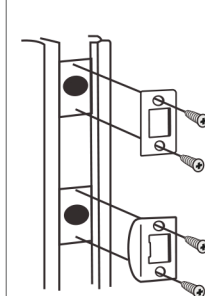

THANKS FOR CHOOSING US. WE HOPE YOU ENJOY YOUR NEW WESLOCK DOOR HANDLE.

#### WESLOCK WARRANTY INFORMATION

WESLOCK warrants to the purchaser that the products shall be free from defects in material workmanship for the LIFETIME of the product. Provided the product was purchased from an authorized WESLOCK dealer, Weslock's sole obligation under this warranty shall be to repair or replace product which WESLOCK determines to be defective. After such product is returned to WESLOCK by the purchaser with proof of purchase and with shipping charges prepaid, will this warranty be honored. Homeowner - if the product was installed as original equipment on a new home, you must provide the name of the builder, the date the home was built and your move-in date. If a mechanical defect has occurred, it is your right by this warranty to contact Customer Service in Tulsa, Oklahoma at (800) 575-2658 to arrange the return of the lock. This warranty DOES NOT cover products which malfunction due to improper installation or misuse. **Please register your product at [Weslock.com](http://Weslock.com).**

#### WARRANTY TERMS

#### FINISH

#### MECHANICAL

Transitional Collection

Limited 5 year finish

Limited 25 year

#### ADDITIONAL CUSTOMER RESOURCES

##### Online

##### WEBSITE

For our full product catalog, and video instructions, go to;

www.weslock.com

##### TWITTER

To learn about promotions, and other news, follow us at;

twitter.com/Weslock1

##### YOUTUBE

Browse our video library, or leave us comments at;

youtube.com/WeslockDoorHardware

##### FACEBOOK

See what we're up to, or ask us a question at;

facebook.com/WeslockDoorHardware

##### Direct

##### PHONE NUMBER

1-800-575-2658  
BOLT

##### FAX NUMBER

1-918-294-3869

##### EMAIL

customerservice@weslock.com  
or  
warranty@weslock.com

# TEMPLATE

