

PL-160 Square Privacy Installation Diagram

(Minimum Door Thickness 1-3/8")

SKU: PL160S-ST-PR

PL-160 Trim Requires Precise Installation.
Otherwise, It May Not Function Properly.

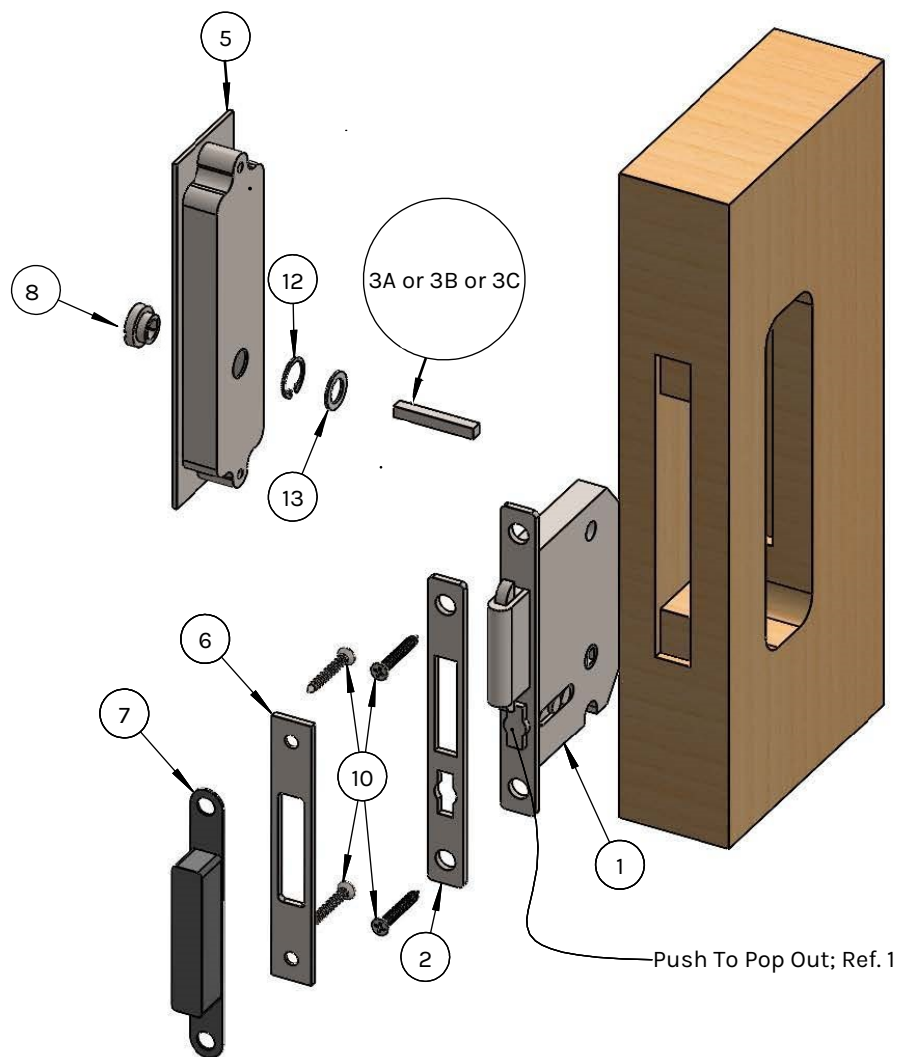

1. Knob and emergency release are supplied pre-installed.
2. Trims are not required to be recessed to accommodate pocket width; but a door thickness 1-3/4" is required if opting for a recessed trim. Trims cannot be recessed on a 1-3/8" thick door.
3. Measure the trim dimensions before cutting the door due to minor tolerances in overall dimensions.
4. The backset of the mortise lock case is 52.5mm (metric). A 2" backset will not allow proper function.

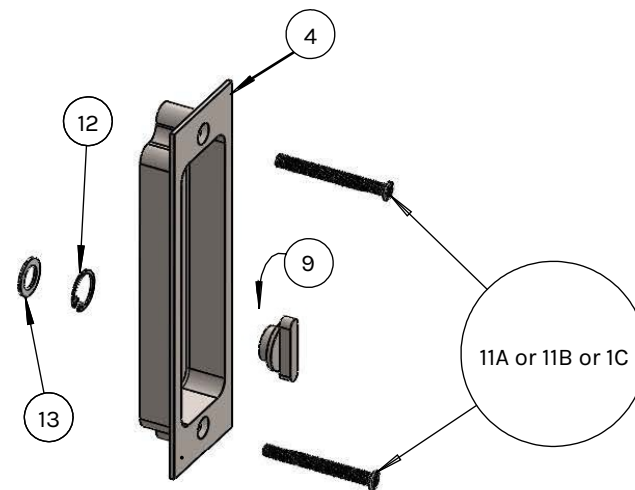

Component List

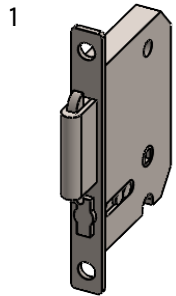

1
Mortise Lock
 PLM-50PR-UNF
 (Needs 1)

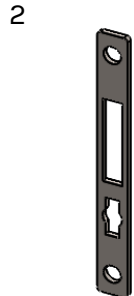

2
Face Plate
 PLM-50PR-FP
 (Needs 1)

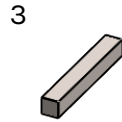

3
Spindle
 3A: PL-SPDL31
 3B: PL-SPDL36
 3C: PL-SPDL41

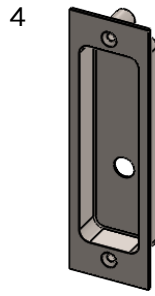

4
Inside Trim
 PLA-160ST-I
 (Needs 1)

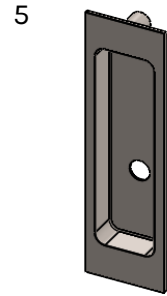

5
Outside Trim
 PLA-160ST-O
 (Needs 1)



6
Strike Plate
 PLM-50PR-ST
 (Needs 1)

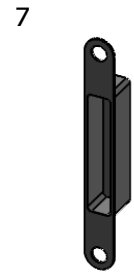

7
Dust Box
 PL-DBOX160
 (Needs 1)



8
Emergency Release
 PL-KNER
 (Needs 1)



9
Turnpiece
 PL-KNBAR
 (Needs 1)



10
Wood Screw
 #8 x 3/4
 (Needs 4)



12
Snap Ring
 PL-CCLIP11
 (Needs 2)



11
Machine Screw
 11A: PL-OVSCR36
 11B: PL-OVSCR40
 11C: PL-OVSCR46

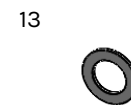

13
Plastic Washer
 PL-WAS12
 (Needs 2)

